



Starion's spokesmodel (Korean Actor)
KIM HO JIN

A handwritten signature in black ink, appearing to read "Kim Ho Jin", positioned below the printed name.



Starion Product Guide

| Commercial refrigerators 03 | Side-Dish Table refrigerators 05 | Dish Washer 08 |
| Electric Range 09 | Standing Fan/Airo-Cook 12 | Rotary Heater 13 | Heater 14 |

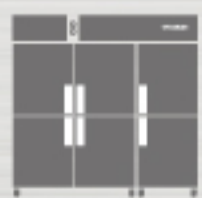

STARION



Starion Group



o Oversea incorporation establishment state below:

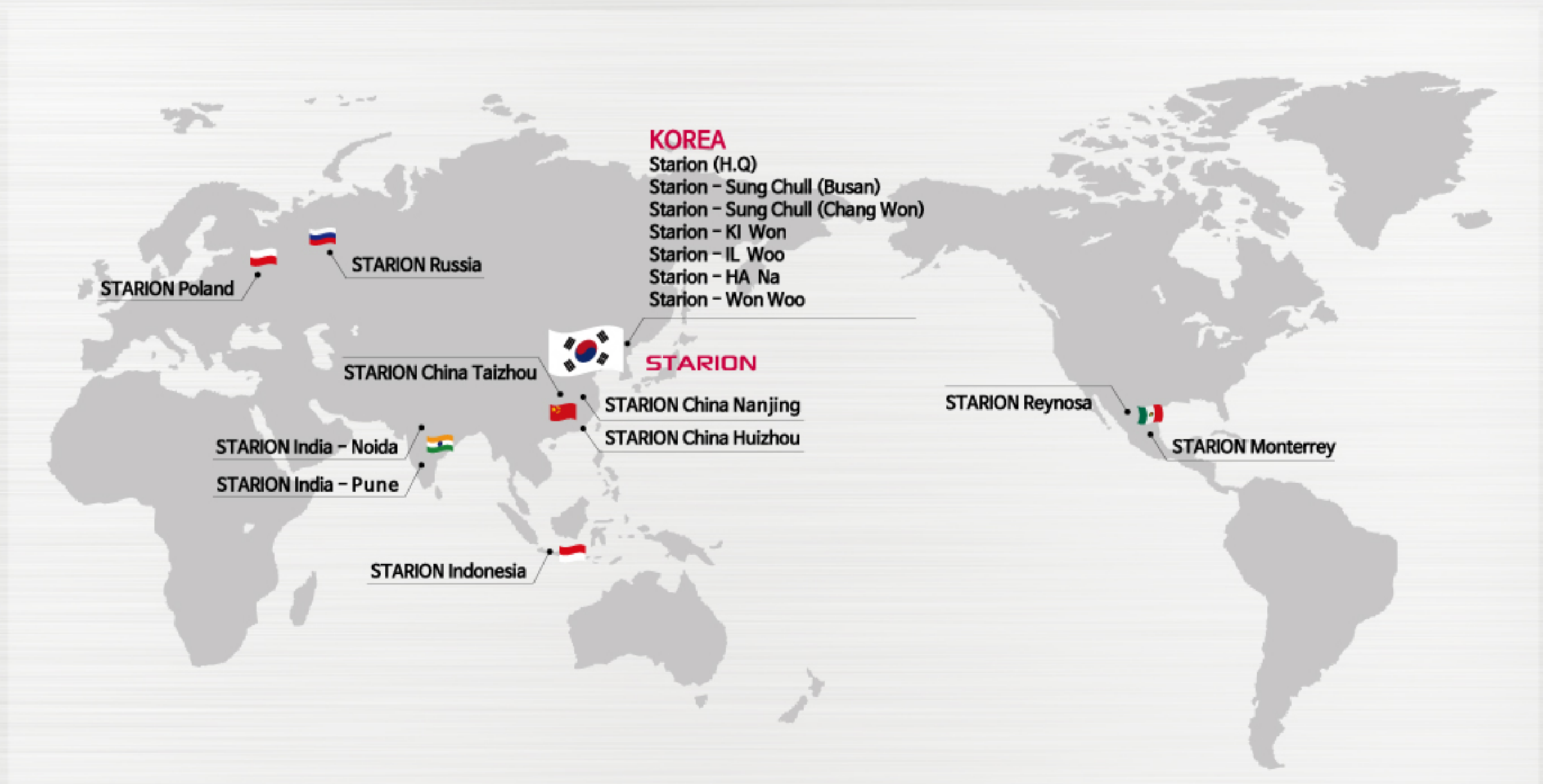

Keep the ingredients fresher!

Starion's 50years of technology guarantee you the quality .



2grade of Energy Efficiency Standard

Everyday refrigerator is working and worry about electric fee Starion commercial refrigerators is out of electric fee! (only for cold store product, the others might be 3 grade)



1year electric fee is only 100USD

67% cheaper than competitor company's product (SR-S45A*,testing result under the standard of ISO5502)



43dB Designed as low noise

Seem like not working?! It is definitely working! (SR-S25D *Only for this model)



No silicon, no mold!

No need to worry about the mold from refrigerator, and there is no silicon in between the gaps present in the refrigerator.

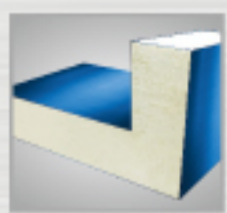

High density polyurethane Foaming

We differentiated the Thickness of foaming for each part by minimizing the waste of heat in the interior & exterior and researching on the optimal thickness.



Automatically closing door on 45 degree angle

Automatically door closing function is automatically closing the door during the state of DOOR OPENED within 45 degree angle and is needed for kitchens in business who often have to open and close the refrigerator door.

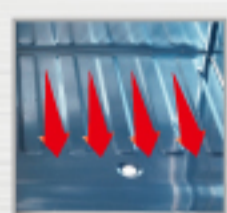

A Drain structure that considers its users

We designed the back of the refrigerator 1 degree higher than the front part of it, and additionally made waterway so that water will naturally gather in the front part. The drainage and cleaning can be easily done through the drainage hole located in-front, without having to remove the foods that were inside the refrigerator.



Quick freeze in refrigerator

Automatically will be shut off in 2hours of operation when you press the button. You can store ingredients fast and easy with only press button one time.



Defrost the Freezer

Functionally defrost the freezer, frost by outside-air when you open the fridge hence possible to store the ingredients efficiently.

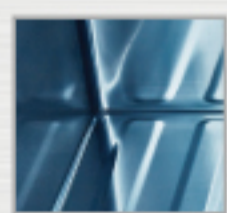

Designed by Internal Stainless

Designed by premium stainless, easy to cleaning and maintenance.



Easy to handle attemperation device

Temperature control is freely done by the application of sensor, and external identification is made simple. And we maintain freshness of food for long time with its best condition.



Adoption of the strong refrigerating capacity LG COMPRESSOR

We provide a strong refrigerator with the LG compressor, which is the byword for compressor.



Adjustable height of the rack

It is possible to make use of the space rationally depending on the quantity of food stored by applying a rack with adjustable height.



To removing a bottle rack for larger storage space

Starion refrigerator is designed as removing the bottle rack so more ingredients able to store.

STARION | Commercial refrigerator



2 grade of Energy efficiency

Everyday refrigerator is working and worry about electric fee Starion commercial refrigerator is out of electric fee! (only for cold store product, the others might be 3 grade)



43dB Designed as low noise

Seem like not working? It is definitely working! (SR-S25D *only this model)



No Silicon, No Mold !

No need to worry about the mold from refrigerator, there is no silicon in between the gaps present in the refrigerator.

1100ℓ 45Box - Metal



Type	Model No.	Material		SIZE (WxDxH)mm	Weight (kg)	Voulme(ℓ)			Temperature Range		Power Consumption (kWh/M)
		External	Internal			Freezer	Fridge	Total	Freezer	Fridge	
 1100ℓ 1/4 freezer	SR-S45AI	Metal	STS	1,260x805x1,909	157	240	830	1,070	6 Level temperature control (-24℃ ~ 5℃) Rapidly: 32℃ ▶ -5℃ : 58mins	6 Level temperature control (-5℃ ~ 7℃)	63.0 2 grade of Energy efficiency
	SR-S45AS	STS	153								
 1100ℓ 1/2 freezer (Verticality)	SR-S45BI	Metal	STS	1,260x805x1,909	147	530	530	1,060	6 Level temperature control (-24℃ ~ 5℃) Rapidly: 32℃ ▶ -5℃ : 79mins	6 Level temperature control (-5℃ ~ 7℃)	80.0 2 grade of Energy efficiency
	SR-S45BS	STS	145								
 1100ℓ 1/2 freezer (Horizontality)	SR-S45CI	Metal	STS	1,260x805x1,909	145	532	541	1,073	6 Level temperature control (-24℃ ~ 5℃) Rapidly: 32℃ ▶ -5℃ : 79mins	6 Level temperature control (-5℃ ~ 7℃)	86.0 3 grade of Energy efficiency
	SR-S45CS	STS	141								
 1100ℓ All freezer	SR-S45DI	Metal	STS	1,260x805x1,909	140	1,110	-	1,110	6 Level temperature control (-24℃ ~ 5℃) Rapidly: 32℃ ▶ -5℃ : 82mins	-	-
	SR-S45DS	STS	138								
 1100ℓ All Fridge	SR-S45EI	Metal	STS	1,260x805x1,909	124	-	1,110	1,110	-	6 Level temperature control (-5℃ ~ 7℃)	35.0 2 grade of Energy efficiency
	SR-S45ES	STS	120								

1100ℓ 45Box - Stainless



1700ℓ 65Box



Type	Model No.	Material		SIZE (WxDxH)mm	Weight (kg)	Voulme(ℓ)			Temperature Range		Power Consumption (kWh/M)
		External	Internal			Freezer	Fridge	Total	Freezer	Fridge	
 1700ℓ 1/3 freezer	SR-S65BI	Metal	STS	1,900x805x1,909	212	500	1,110	1,610	6 Level temperature control (-24℃ ~ 5℃) Rapidly: 32℃ ▶ -5℃ : 82mins	6 Level temperature control (-5℃ ~ 7℃)	98.0 2 grade of Energy efficiency
	SR-S65BS	STS	204								
 1700ℓ All freezer	SR-S65DI	Metal	STS	1,900x805x1,909	228	1,610	-	1,610	6 Level temperature control (-24℃ ~ 5℃) Rapidly: 32℃ ▶ -5℃ : 79mins	-	N/A
	SR-S65DS	STS	222								
 1700ℓ All Fridge	SR-S65EI	Metal	STS	1,900x805x1,909	210	-	1,610	1,610	-	6 Level temperature control (-5℃ ~ 7℃)	49.0 3 grade of Energy efficiency
	SR-S65ES	STS	204								

500ℓ 25Box



Type	Model No.	Material		SIZE (WxDxH)mm	Weight (kg)	Voulme(ℓ)			Temperature Range		Power Consumption (kWh/M)
		External	Internal			Freezer	Fridge	Total	Freezer	Fridge	
 500ℓ 1/2 freezer	SR-S25AI	Metal	STS	640x805x1,909	85	244	240	484	6 Level temperature control (-24℃ ~ 5℃) Rapidly: 32℃ ▶ -5℃ : 58mins	6 Level temperature control (-5℃ ~ 7℃)	22.0 2 grade of Energy efficiency
	SR-S25AS	STS	83								
 500ℓ All freezer	SR-S25DI	Metal	STS	640x805x1,909	83	500	-	500	6 Level temperature control (-24℃ ~ 5℃) Rapidly: 32℃ ▶ -5℃ : 79mins	-	N/A
	SR-S25DS	STS	79								
 500ℓ All Fridge	SR-S25EI	Metal	STS	640x805x1,909	81	-	500	500	-	6 Level temperature control (-5℃ ~ 7℃)	22.0 2 grade of Energy efficiency
	SR-S25ES	STS	79								

※ STS = Stainless



Easy of Use
Best Design, Maximized and
Convenient Storage Space

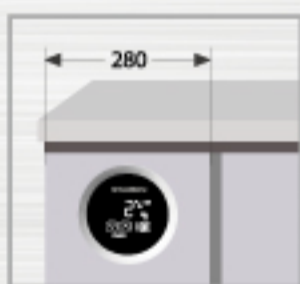

Innovation of mechine room (280mm)

We provide a larger storage space by innovatively reducing the machine area with the best compressor load.



No silicon, no mold !

No need to worry about the mold from refrigerator, and there is no silicon in between the gaps present in the refrigerator.



Easy to use temperature control

The temperature of the refrigerator can be checked at a glance and its temperature can be controlled in a very convenient way.



Installed powerful refrigeration-ability of LG compressor

As we selected LG compressor, provide refrigeration ability and unnecessary to shift machine room due to surrounding environment.



Defrost the Freezer

Possible to give it a hose through the drain once frosts are removed! Cleanness maintained for 365days! Possible of clean storage!



Delicate temperature control of 1 degree celsius unit)

With digital touch screen, it is possible to control the temperature by 1 degree celsius unit.



Adjustable the height of a rack

It is possible to make use of the space rationally depending on the quantity of food stored by applying a rack with adjustable height.



Type	Model No.	Material		SIZE (WxDxH)mm	Weight (kg)	Volume(ℓ)			Temperature Range Fridge	Remark	
		External	Internal			Upper Storage	Fridge	Total			
W900 Side-Dish Refrigerator  4	SR-V09EIE	Metal		900x700x850	54					Left handle	
	SR-V09EIF		STS							Right handle	
	SR-V09ESE		STS							Left handle	
	SR-V09ESF		STS							Right handle	
W1000 Side-Dish Refrigerator  4	SR-V10EIE	Metal		900x700x850	56	62	131	193	-5°C ~ 10°C (Adjustable by 1°C unit)	Left handle	
	SR-V10EIF		STS							Right handle	
	SR-V10ESE		STS							Left handle	
	SR-V10ESF		STS							Right handle	
W1200 Side-Dish Refrigerator  W1200 1/2  W1200  W1200 1/3 3 6 5	SR-V12EIE	Metal		1,200x700x850	65	86	209	295	-5°C ~ 10°C (Adjustable by 1°C unit)	Left handle	
	SR-V12EIF		STS							Right handle	
	SR-V12ESE		STS							Left handle	
	SR-V12ESF		STS							Right handle	
	SR-V12EIEVB	Metal	STS							Left handle	
	SR-V12ESEVB		STS							Left handle	
	SR-V12EIEVA	Metal								Left handle	
	SR-V12EIFVA									Right handle	
W1300 Side-Dish Refrigerator  6	SR-V13EIE	Metal		1,300x700x850	67	86	209	295	-5°C ~ 10°C (Adjustable by 1°C unit)	Left handle	
	SR-V13EIF		STS							Right handle	
	SR-V13ESE		STS							Left handle	
	SR-V13ESF		STS							Right handle	
W1500 Side-Dish Refrigerator  W1500  W1500 1/2  W1500 1/3 8 4 7	SR-V15EIE	Metal		1,500x700x850	74	109	287	396	-5°C ~ 10°C (Adjustable by 1°C unit)	Able to open Two-door	
	SR-V15ESE		STS								Left handle
	SR-V15EIEVB	Metal	STS								Left handle
	SR-V15ESEVB		STS								Left handle
W1800 Side-Dish Refrigerator  W1800 10	SR-V18EIE	Metal		1,800x700x850	89	132	365	497	-5°C ~ 10°C (Adjustable by 1°C unit)	Able to open Two-door	
	SR-V18ESE		STS								Left handle

4 * Number of Side-dish container * STS = Stainless

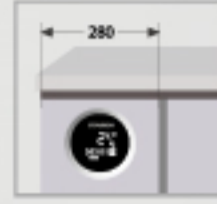

Innovation of mechine room (280mm)

We provide a larger storage space by innovatively reducing the machine area with the best compressor load.



No silicon, no mold!

No need to worry about the mold from side-dish&table, and there is no silicon in between the gaps present in the refrigerator.



Easy to use temperature control

The temperature of the refrigerator can be checked at a glance and its temperature can be controlled in a very convenient way.

Type	Model No.	Material		SIZE (WxDxH)mm	Weight (kg)	Volume(ℓ)			Temperature Range		Remark
		External	Internal			Upper Storage	Fridge	Total	Fridge		
W900 Table Refrigerator	SR-T09EIE	Metal	STS	900x700x850	54	-	167	167	-5°C ~ 10°C (Adjustable by 1°C unit)		Left handle
	SR-T09EIF										Right handle
	SR-T09ESE	Left handle									
	SR-T09ESF	Right handle									
W1000 Table Refrigerator	SR-T10EIE	Metal	STS	1,000x700x850	56	-	167	167	-5°C ~ 10°C (Adjustable by 1°C unit)		Left handle
	SR-T10EIF										Right handle
	SR-T10ESE	Left handle									
	SR-T10ESF	Right handle									

Type	Model No.	Material		SIZE (WxDxH)mm	Weight (kg)	Volume(ℓ)			Temperature Range		Remark
		External	Internal			Upper Storage	Fridge	Total	Fridge		
W1200 Table Refrigerator	SR-T12EIE	Metal	STS	1,200x700x850	65	-	266	266	-5°C ~ 10°C (Adjustable by 1°C unit)		Left handle
	SR-T12EIF										Right handle
	SR-T12ESE	Left handle									
	SR-T12ESF	Right handle									
W1300 Table Refrigerator	SR-T13EIE	Metal	STS	1,300x700x850	67	-	266	266	-5°C ~ 10°C (Adjustable by 1°C unit)		Left handle
	SR-T13EIF										Right handle
	SR-T13ESE	Left handle									
	SR-T13ESF	Right handle									

Type	Model No.	Material		SIZE (WxDxH)mm	Weight (kg)	Volume(ℓ)			Temperature Range		Remark					
		External	Internal			Upper Storage	Fridge	Total	Freezer	Fridge						
W1500 Table Refrigerator	SR-T09EIE	Metal	STS	1,500x700x850	74	-	366	366	-	-5°C ~ 10°C (Adjustable by 1°C unit)	Able to open Two-door					
	SR-T09EIF															
W1500 Table (Freezer/Fridge)	SR-T15AIE	Metal	STS		TBD						171.5	171.5	171.5	343	-25°C ~ -15°C (Adjustable by 1°C unit)	Able to open Two-door
	SR-T15ASE															
W1800 Table Refrigerator	SR-T18EIE	Metal	STS	1,800x700x850	89	-	465	465	-	-5°C ~ 10°C (Adjustable by 1°C unit)	Able to open Two-door					
	SR-T18ESE															
W1800 Table (Freezer/Fridge)	SR-T18AIE	Metal	STS		TBD						171.5	171.5	271.5	443	-25°C ~ -15°C (Adjustable by 1°C unit)	Able to open Two-door
	SR-T18ASE															

* STS = Stainless

STARION | Dishwasher



Simple display and convenient instructions

Aimed convenience of the users by minimizing the control buttons and expressing all the of the washer on the display screen.

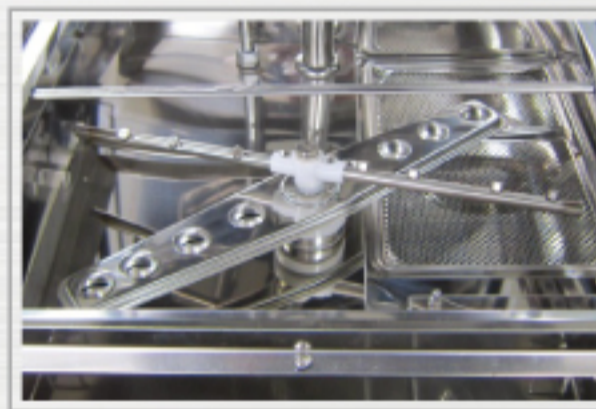

Strong cleaning power of the water jet injection

Through Starion's exclusive cleaning nozzle, where the strong wash water pump is at its optimum round Bowls, cups, and bottle can be cleaned thoroughly without leaving any stain.

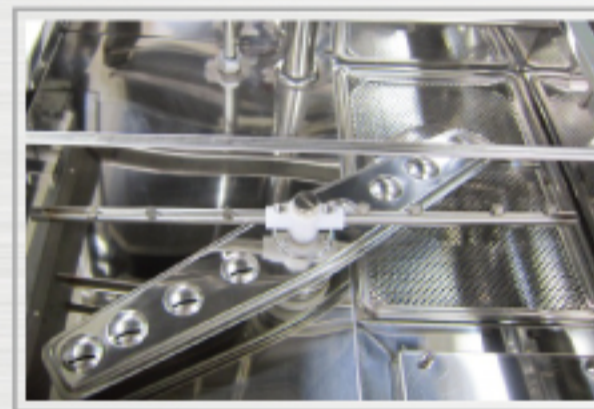

A water tank that does not rust do not have any leaks

Due to the same quality of material (stainless), there is no leakage.



Duration of cleaning

Average time: 70 sec
(Washing :55sec, stopping: 3sec, rinsing: 12sec)
Cleaning and rinsing time can be controlled according to the tendency of customers.



Pausing and self-diagnosing function

By applying the thermal fuse and overweight prevent devices if a problem occurs, the error sign and application of pausing function will stop the washer action and let it relax to aim for safety.



Possible to control the cleanliness Standard acquisition on the surrounding environment

We optimized the requirements of washer by regulation not only cleansing, washing time, but also detergent and rinse.



Accredited of Safety certification

products that are accepted for their quality and safety by undergoing safety certified products.



Applying detergent rinse, and feeder for slump

Instead of roll pumps, it can be used conveniently with no minor breakdowns, by applying the slump that has strong detergent reaction, and using the right amount of detergent

Type	Model No.	Weight	Size (WxDxH)mm	Voltage	Maximum Electric Power	Washing-Rinse				Cleaning Power(Per hour)					
						Mode	Tank Capacity	Washing · Rinse Time	Pump Capacity	Hot Water	Maximum Temperature	Small/Mdium size of plate types	Rice bowl types	Noddle bowl types	Glass types
Dishwasher	SW-D500C	80 Kg	Door-closed 650x650x1,350	220V~, 60Hz Single -phase current	3.8 kW	spary Up and down / rotary mode	Washing : 42 Li Rinsing : 28 Li	Washing : 35 ~ 95sec (Adjustable by 5sec) Rinsing : 5 ~ 30sec (Adjustable by 1sec)	Washing : 1.1 kW Rinsing : 0.1 kW	X	Washing 85°C ± 10%	1,500 ~ 1,800개	1,500개	360 ~ 480개	2,000개
	SW-D500H	85 Kg	Door-opend 650x650x1,850	5 kW	O										

Dishwasher customer service **1588-2463** Starion provides own direct supporting service for your convenience and better services (only Dish-Washer)



Cooking through a starion electric stove offer healthy foods

**Wonderful Kitchen,
dreaming of wonderful Style!**



Adoption of German's SCHOTT

SCHOTT Glass well-know for best durability and thermal efficiency



Adoption of German's G.E.O

3~5sec of heating speed, 650°C~700°C
Prevent the destory of nutrient

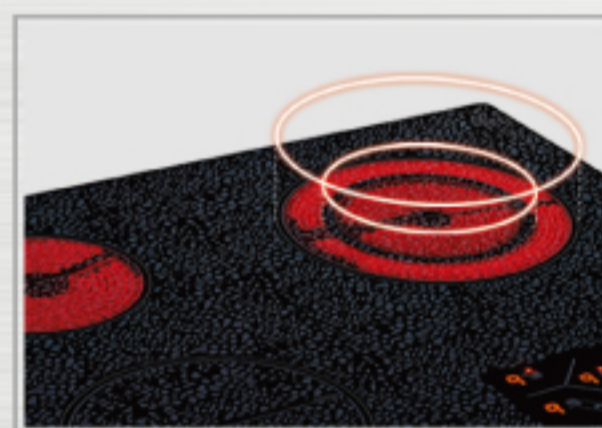

Adoption of dual wide burner

Possible to use from small pot to big pot

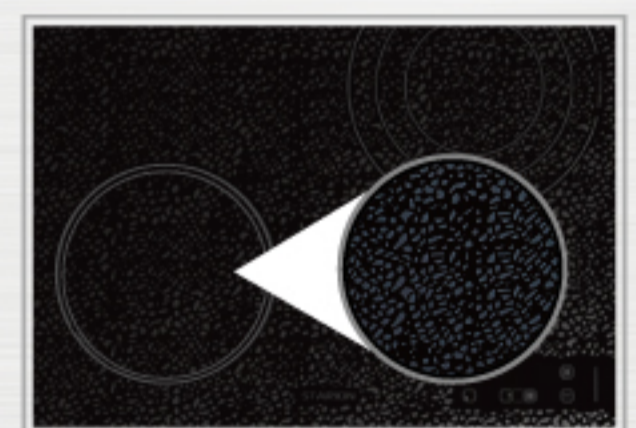

Applied Euro style's pattern

Applied anti-fingerprint
Good for prevention of contamination



Easy to clean

through the easy and simple to clean
everydays stove keep clean

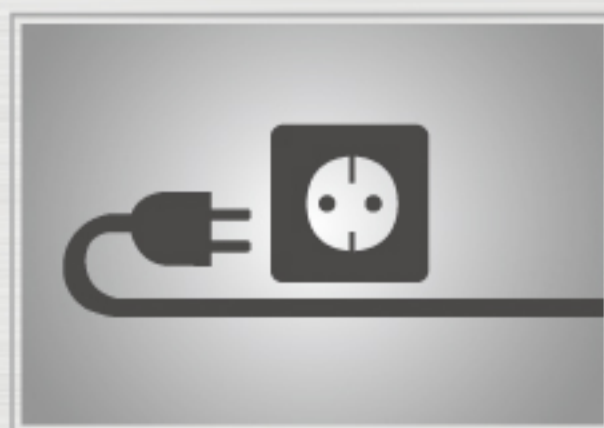

Directly connect to power plug

Installation of Starion product
(Only offer to who buy free stand)



Slide / Soft Touch Mode

Convenience in use and sensitive touch
mode with finger



Smart Safety Device

Child-lock, Automatic turn off mode,
automatic power off Accident prevention f
unction including

STARION | 3 Burners Hybrid / 3 Burners Highlight



Installation of various places

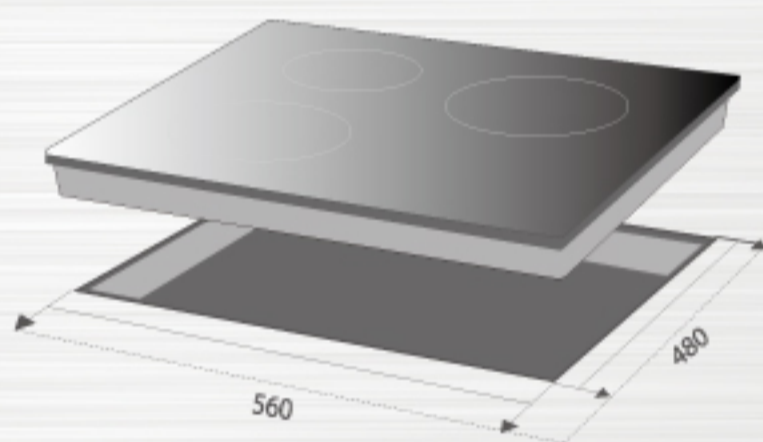

- Possible to install of your kitchen (※ Standing type case is not including)
- Built-in/ Standing type case (150mm / 80mm)
Requirement Size : 560(W)x480(D)

Comparison of consumption in time and energy for boiling 1L of water

Boiling Time (25°C → 100°C)



SE-HY63SIC
Hybrid 3 burners



SE-HLP63SIA
Highlight 3 burners



SE-HL63SIA
Highlight 3 burners



SE-HL63SIB
Highlight 3 burners

Type	Model No.	Glass Type	Heating Element	SIZE (WxDxH)mm	Power Consumption	Level of heat power	Functions	Timer	Pause mode	Voice guide	Control Mode
Hybrid 3 burners	SE-HY63SIC	SCHOTT	E.G.O	590x510x52	3,300W	9 Levels	HighSpeed Heatup/ Warning system Automatically turn off / Child lock	○	○	○	Touch & Slide
Highlight 3 burners	SE-HLP63SIA	SCHOTT	E.G.O	590x510x52	3,300W	9 Levels	Child lock / Warning system Automatically turn off	○	○	○	Touch & Slide
	SE-HL63SIA	N.E.G	Ceramiste	590x510x52	3,300W	9 Levels	Child lock / Warning system Automatically turn off	X	X	○	Touch
	SE-HL63SIB	N.E.G	Ceramiste	590x510x52	3,300W	9 Levels	Child lock / Warning system Automatically turn off	X	X	X	Touch

※ Induction burner accept for induction container only

STARION | 2 Burners Highlight · 1 burners Induction



Highlight Electric Stove

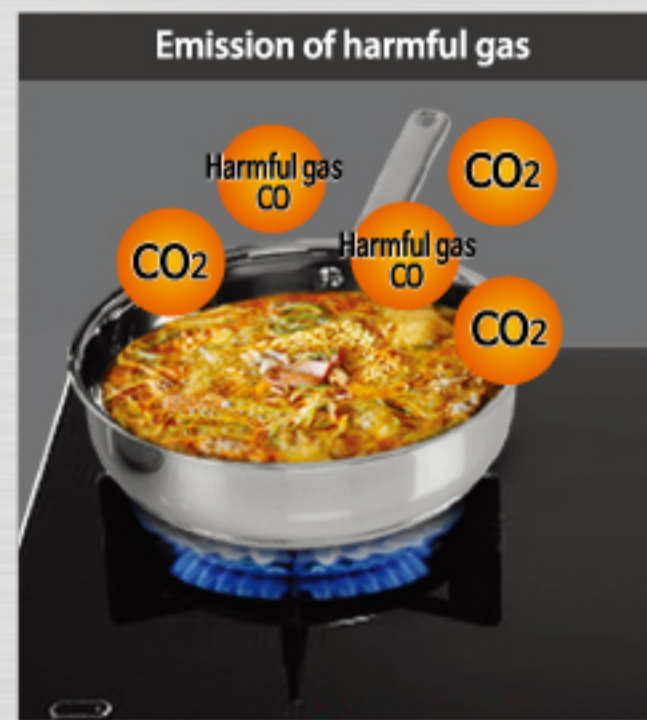

Gas Stove

No more worry about harmful gas
Starion Electric Stove!

Though the easy and simple cleaning,
Use it always cleanly

Premium Kitchen starts from Premium Stove



SE-HL62SIA
Highlight 2 burners



STI2100-WBW
Induction 1 burner (White)



STI2100-BCB
Induction 1 burner (Black)

Type	Model No.	Glass Type	Heating Element	SIZE (WxDxH)mm	Power Consumption	Level of heat power	Functions	Timer	Pause mode	Voice guide	Control Mode
Highlight 2 burners	SE-HL62SIA	SCHOTT	Ceramiste	590x510x52	3,300W	9 Levels	Automatically turn off/ Warning system	○	○	○	Touch

Type	Model No.	Glass Type	Color	SIZE (WxDxH)mm	Power Consumption	Level of heat power	Functions	Timer	Pause mode	Voice guide	Control Mode	Display
1burner Induction	STI2100	Borosilicate Glass	White	378x293x55	2,100W	15 Levels	HighSpeed Heatup Heat Insulation/ Warning system	○	○	x	Touch	Hidden LED
	STI2100-WBW							○	○	○		
	STI2100-BCB	Ceramics Glass	Black					○	○	○	Printing	

STARION | Standing Tower Fan · Airo-Cook



Type	Model No.	Color	Power Consumption	SIZE (WxDxH)mm	Weight	Screen	Touch system	Remote Control	Timer	Sleeping mode
타워팬 선풍기	SF-T4011RH STF-B40CCB	All Black	40W	257x300x985	4.5Kg	LCD (Orange)	Button	○	7.5 (0.5hr)	LCD Lighting ON/OFF
	SF-T4014RH STF-B40CCWB	White & Black	40W	257x300x985	4.5Kg	LCD (Orange)	Button	○	7.5 (0.5hr)	LCD Lighting ON/OFF
	SF-T4015RH	All White	40W	257x300x985	4.5Kg	LCD (Orange)	Button	○	7.5 (0.5hr)	LCD Lighting ON/OFF
	STF-B42CCPB	Purple & Black	45W	300x350x1,050	6.0kg	LCD (Blue)	Button	○	7.5 (0.5hr)	X
	SF-T4512RH STF-B42CCDB	Dark Walnut & Black	45W	300x350x1,050	6.0kg	LCD (Blue)	Button	○	7.5 (0.5hr)	X



ECO
Made by new material of TRX
0% of endocrine disruptor



Big Capacity
Possible to cook lashings of foods at a time



Safety Devices
Safe cooking is allowed with 5 steps of safety device safety laver(ON/OFF) system, mechanical heating protect device, main part and · ball part apparatus for shutting off a power supply protection of motor overheating device, Protection of PCB-overheating device



Convenience in use
LED touch pad / Possible to Adjust by minute unit and 5 degree unit / Easy to clean due to applied TPX

Type	Model No.	Power Consumption	SIZE (WxDxH)mm	Voulme	Rated Voltage	Weight	Safety Device
Airo-Cook	STO-1200	Halogen lamp/1,200W	375x360x375	14.5L	220V / 60Hz	Approx. 5kg	5steps of Safety device

STARION | Heater · Rotary Heater



**No.1 sales
in KOREA for 15years**

**Powerful and high efficiency burner
makes your places warm quickly**



**No.1
in KOREA for 15years**

43m²
6,500Kcal
Audio guidance

**43m²
SH-R06VCG**

Light Brown
Vaporization high pressure discharge ignition
Audio guidance

- Caloric Value: 6,500 Kcal
- Tankage: 16.5ℓ
- Fuel Consumption:
Max. combustion 0.78(ℓ/h)
- Fuel Sustainment time :
Maximum combustion approx.18hr
- Size((WxDxH) : 441x541x700mm
- Weight: 19.5 kg
- Power Consumption Value: 30W(Combusting)



**43m²
SH-R06SCG**

Light Brown
Vaporization high pressure discharge ignition
Audio guidance

- Caloric Value: 6,500 Kcal/h
- Tankage: 16.5ℓ
- Fuel Consumption:
Max. combustion 0.78(ℓ/h)
- Fuel Sustainment time :
Maximum combustion approx.18hr
- Size((WxDxH) : 441x541x700mm
- Weight: 19.5 kg
- Power Consumption Value: 30W(Combusting)



**56m²
SH-R08SCG**

Light Brown
Vaporization high pressure discharge ignition
Audio guidance

- Caloric Value: 8,000 Kcal/h
- Tankage: 16.5ℓ
- Fuel Consumption:
Max. combustion 0.97(ℓ/h)
- Fuel Sustainment time :
Maximum combustion approx.15hr
- Size((WxDxH) : 441x541x700mm
- Weight: 19.5 kg
- Power Consumption Value: 35W(Combusting)



**79m²
SH-R11SCG**

Light Brown
Spin atomization high pressure discharge ignition
Audio guidance

- Caloric Value: 11,500 Kcal/h
- Tankage: 20ℓ
- Fuel Consumption:
Max. combustion 1.35(ℓ/h)
- Fuel Sustainment time :
Maximum combustion approx.13hr
- Size((WxDxH) : 473x574x785mm
- Weight: 23.5 kg
- Power Consumption Value: 26W(Combusting)



**56m²
SH-R08VCG**

Light Brown
Vaporization high pressure discharge ignition
Audio guidance

- Caloric Value: 8,000 Kcal/h
- Tankage: 16.5ℓ
- Fuel Consumption:
Max. combustion 0.97(ℓ/h)
- Fuel Sustainment time :
Maximum combustion approx.15hr
- Size((WxDxH) : 441x541x700mm
- Weight: 19.5 kg
- Power Consumption Value: 35W(Combusting)



**79m²
SH-R11SBG**

Light Brown
Spin atomization high pressure discharge ignition
Audio guidance

- Caloric Value: 11,500 Kcal/h
- Tankage: 20ℓ
- Fuel Consumption:
Max. combustion 1.35(ℓ/h)
- Fuel Sustainment time :
Maximum combustion approx.13hr
- Size((WxDxH) : 473x574x785mm
- Weight: 23.5 kg
- Power Consumption Value: 26W(Combusting)



**102m²
SH-R15SCG**

Light Brown
Spin atomization high pressure discharge ignition
Audio guidance

- Caloric Value: 15,000 Kcal/h
- Tankage: 20ℓ
- Fuel Consumption:
Max. combustion 1.8(ℓ/h)
- Fuel Sustainment time :
Maximum combustion approx.10hr
- Size((WxDxH) : 473x574x785mm
- Weight: 23.5 kg
- Power Consumption Value: 28W(Combusting)



11 functions of safety device

Ignition Safety device	Prevention device of explosion ignition
Protection of over heating	Motor protection device
Prevention device of incomplete	Impact adsorption device
prevention of low fuel	Protection of over heating system
Protection of when electric is gone	3hours automatic fire extinguishing appliance
Combustion control device	

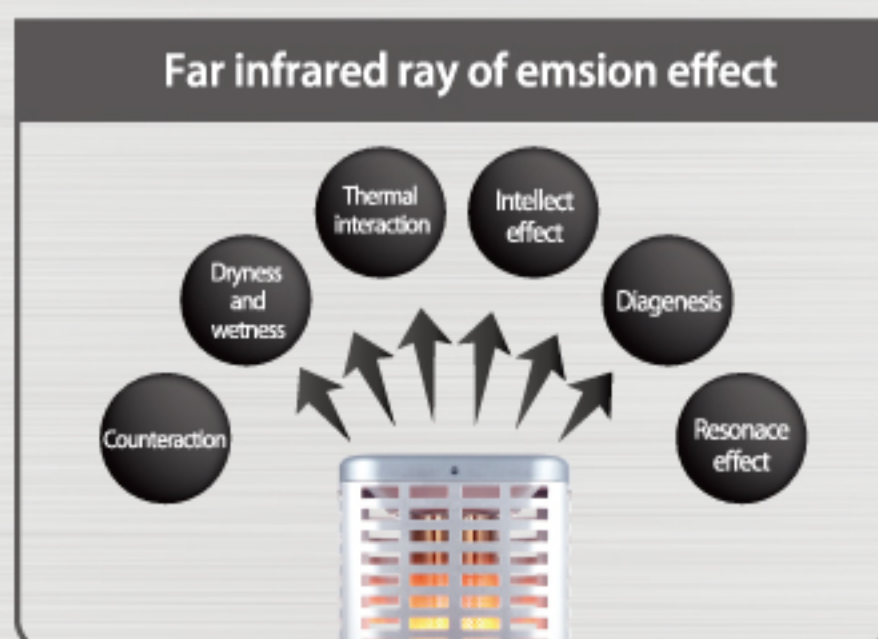

14 Levels of attemperation system

Possible to adjust temperature in 14 levels of attemperation system (Products of a different company only offer 7levels of attemperation system)

STARION | Oil Heater· Heater

Starion heaters are suitable for wide place
Far infrared ray free heating



93m²  

93m²
SH-F10SDG
 Light brown / Remote control
 Audio guidance / Touch switch system
 Applied new WHITE LED

- Calorie: 10,000 Kcal
- Electric power consumption: 70W(during the combustion)
- Tankage: 30ℓ
- Weight: 51.5 kg
- Fuel consumption: 1.1ℓ/h
- Size(WxDxH) : 950x350x1,120mm

Improved 20%



By improved burner, exhaust NOx is 20% lesser

Improved 20%



By applied **BAFFLE** improved heating speed and 20% of fuel efficiency (Applied on SH-09series)



All model applied remote control mode



82.5m² SH-F09SSG

Grey / Applied New COLOR
 Remote control / Audio guidance
 Touch switch system
 Applied new WHITE LED

- Calorie: 9,000 Kcal
- Electric power consumption: 70W(during the combustion)
- Tankage: 30ℓ
- Weight: 46 kg
- Fuel consumption: 1.0ℓ/h
- Size(WxDxH) : 950x350x960mm



82.5m² SH-F09SIG

Grey / Applied New COLOR
 Remote control / Audio guidance
 Touch switch system
 Applied new WHITE LED

- Calorie: 9,000 Kcal
- Electric power consumption: 70W(during the combustion)
- Tankage: 30ℓ
- Weight: 46 kg
- Fuel consumption: 1.0ℓ/h
- Size(WxDxH) : 950x350x960mm
- Derivative model : SH-F09SCG

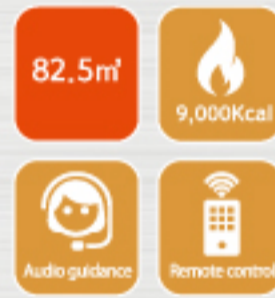

82.5m² SH-F09SRG

Wine Red / Remote control
 Audio guidance
 Touch switch system
 Applied new WHITE LED

- Calorie: 9,000 Kcal
- Electric power consumption: 70W(during the combustion)
- Tankage: 30ℓ
- Weight: 46 kg
- Fuel consumption: 1.0ℓ/h
- Size(WxDxH) : 950x350x960mm

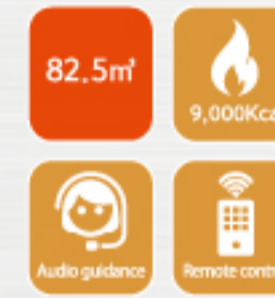

102m² SH-F11SIG

Ivory / Remote control
 Audio guidance
 Touch switch system
 Applied new WHITE LED

- Calorie: 11,000 Kcal
- Electric power consumption: 70W(during the combustion)
- Tankage: 30ℓ
- Weight: 50 kg
- Fuel consumption: 1.2ℓ/h
- Size(WxDxH) : 950x350x1,120mm
- Derivative model : SH-F11SCG

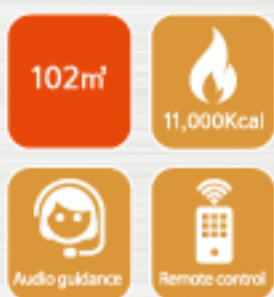

139m² SH-F15SIG

Grey / Remote control
 Audio guidance
 Touch switch system
 Applied new WHITE LED

- Calorie: 15,000 Kcal
- Electric power consumption: 70W(during the combustion)
- Tankage: 30ℓ
- Weight: 64 kg
- Fuel consumption: 1.75ℓ/h
- Size(WxDxH) : 1,150x350x1,280mm
- Derivative model : SH-F15SCG

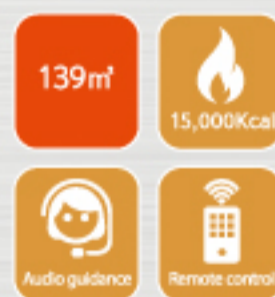







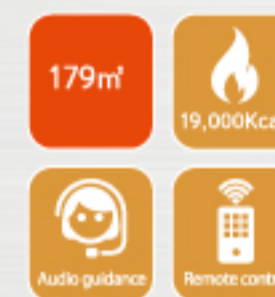

179m² SH-F19SIG

Grey / Remote control
 Audio guidance
 Touch switch system
 Applied new WHITE LED

- Calorie: 19,000 Kcal
- Electric power consumption: 70W(during the combustion)
- Tankage: 30ℓ
- Weight: 70 kg
- Fuel consumption: 2.15ℓ/h
- Size(WxDxH) : 1,300x350x1,280mm



Country's most 12 functions of safety devices (All models are same)

- | | |
|--|--|
|  Protection of over heating |  Revetion device of burner overheating |
|  Ignition Safety device |  Provention of over current |
|  1~3hr automatic fire extinguishing appliance |  Abnormal combustion of control device |
|  Perception of low fuel |  Prevention device of explosion ignition |
|  Motor and Burner protection device |  Impact adsorption device |
|  Protection of when electric is gone |  Its automatically sensor dring a room temperature operating in abnormality |

Concept of high efficiency heater



Common heater of temperature districion Far infrared ray heater temperature distribution

It's suitable for places where wide open spaces or high seiling.

Suitable location for far infrared ray heater



- INDOOR** Lobby(Hotel · Bank · School · Building) restaurant · Rest Room · Hospital · Liblrary Training Institue · Office · Store · Church Petrol Station · Pharmacy, so on
- OUTDOOR** Colf Club · Amusement Park · Outdoor Event hall · Picture Outdoor Location Car Center · Airport · Terminal · Factory Construction location · Ski Resort, so on



Informations of Starion's services center

o **Main service center contact number**

Contact us when you have problem with products
(Everywhere in Korea)

1588-2203

Operation hours

Weekdays | 08:00 ~ 19:00

Saturday | 08:00 ~ 16:30 (Closed on public holiday)

o **Starion Website**

Apply to Starion service center and support

www.starion.co.kr

By internet service provides faster and easier supporting

Starion service center in Korea

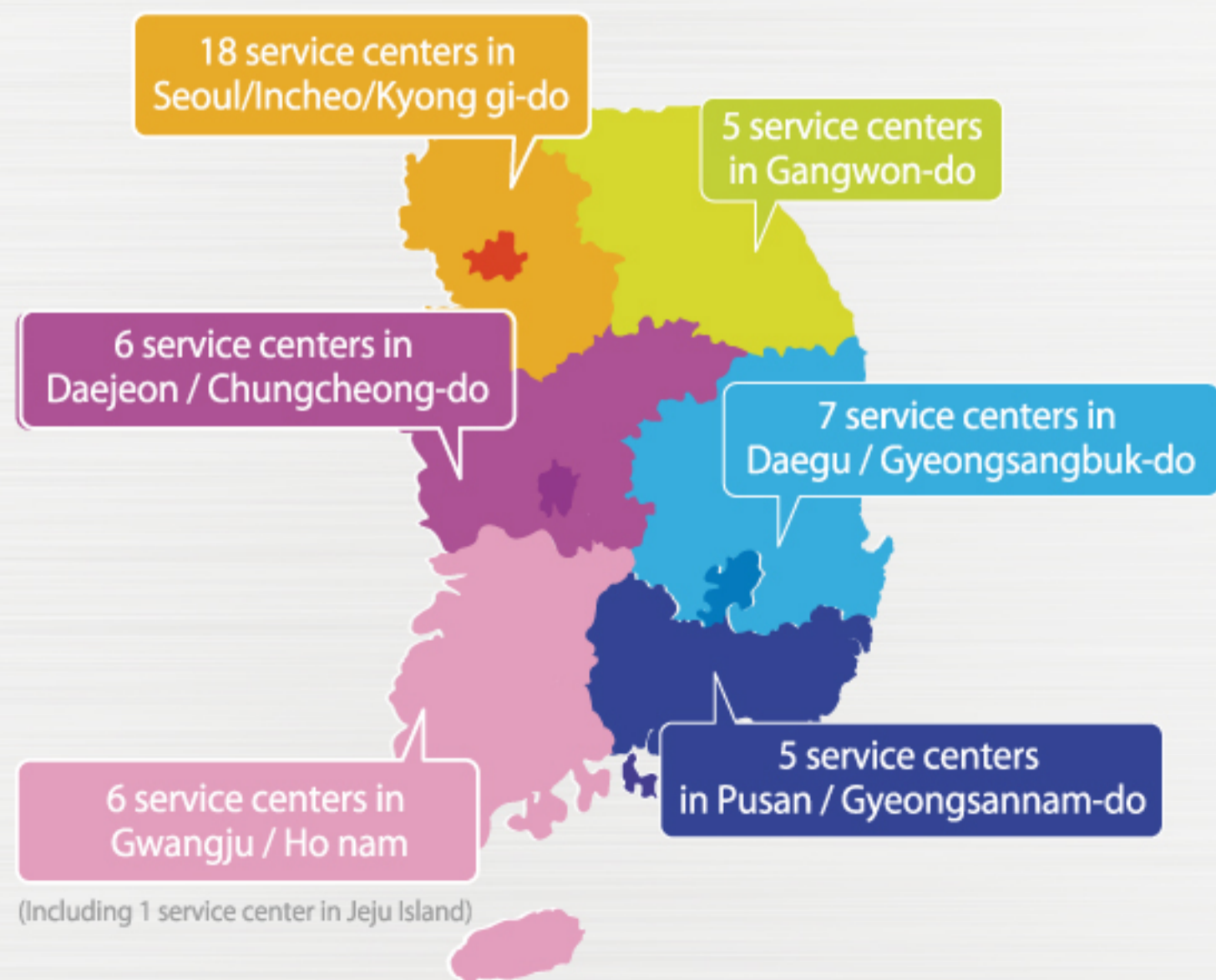



STARION
50years of
Technology skill

**Always think of you first!
Starion will be always with you forever**

Our special products are only for you!
Starion's 50years of technology skill!
that make you more special!



STARION

A/S Center Starion Product Support 1588-2203
(46332) 76, Gondanseo-Ro, 18 Beon-Gill, Geumjeong-Gu, Busan, Korea / www.starion.co.kr

- The introduction of product in this catalogue is aimed to only help customer enhance their understanding regarding the characteristics of the products. And the contents here may be altered due to market trends and the time when it is released. So, when purchasing the product, please check for accurate information from the Salesperson.
- The color of the product shown in this catalog may be different from their original color due to printing process.
- You will be asked for fine responsibility due to copyright law if you will illegally expropriate .